

NPG6-180Ah 6V180Ah

Specifications

Nominal Voltage	6V	
Rated capacity (20 hour rate)	180Ah	
Dimensions	Length	306±2mm(12.05inch)
	Width	169±2mm(6.65inch)
	Height	220±2mm(8.66inch)
	Total Height	225±2mm(8.86inch)
Approx. Weight	29.5kg(65lbs)±3%	



Outer dimensions (mm)

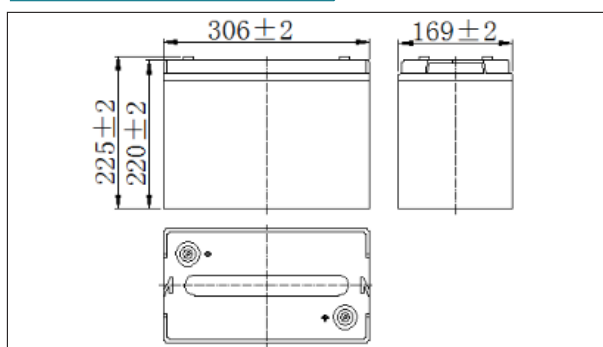

Terminal Type (mm)

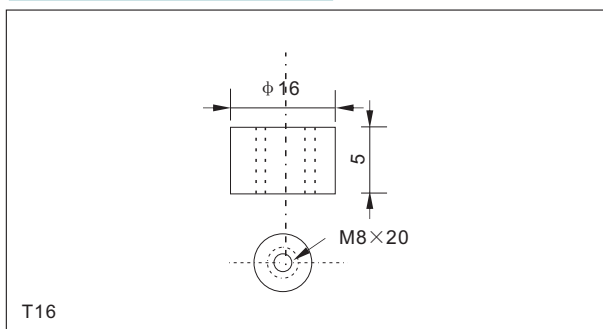

Characteristics

Capacity (25°C)	20HR(5.40V)	180Ah
	3HR(5.40V)	135Ah
	1HR(5.25V)	100Ah
Terminal type		T16
Internal resistance (Fully charged, 25°C)		Approx. 2.2mΩ
Capacity affected by temperature (20HR)	40°C	102%
	25°C	100%
	0°C	85%
	-15°C	65%
Self-discharge (25°C)	3 months	Remaining Capacity: 91%
	6 months	Remaining Capacity: 82%
	12 months	Remaining Capacity: 65%
Nominal operating temperature		25°C ± 3°C (77°F ± 5°F)
Operating temperature range	Discharge	-15°C ~ 50°C (5°F ~ 122°F)
	Charge	-10°C ~ 50°C (14°F ~ 122°F)
	Storage	-20°C ~ 50°C (-4°F ~ 122°F)
Float charging voltage (25°C)	6.75 to 6.90V Temperature compensation: -9mV/°C	
Cyclic charging voltage (25°C)	7.20 to 7.35V Temperature compensation: -15mV/°C	
Maximum charging current	36A	
Maximum discharge current	1250A (5 sec.)	
Designed floating life (20°C)	12 years	

Construction

Component	Positive plate	Negative plate	Container	Cover	Separator	Electrolyte	Safety valve	Terminal
Raw material	Lead dioxide	Lead	ABS	ABS	AGM	Gel	Rubber	Copper

Constant Current Discharge Characteristics Unit: A (25°C, 77°F)

F.V/Time	10min	15min	30min	60min	2h	3h	4h	5h	8h	10h	20h
4.80V	351	288	175	108	65.8	46.8	36.7	31.2	22.0	18.3	9.71
4.95V	340	281	171	106	65.4	46.5	36.5	31.0	21.9	18.3	9.69
5.10V	326	271	166	104	64.8	46.2	36.3	30.8	21.8	18.2	9.66
5.25V	312	262	162	100	63.8	45.9	36.0	30.6	21.6	18.1	9.61
5.40V	295	248	156	97.2	62.2	45.0	34.9	29.7	21.0	18.0	9.54

Constant Power Discharge Characteristics Unit: W (25°C, 77°F)

F.V/Time	10min	15min	30min	60min	2h	3h	4h	5h	8h	10h	20h
4.80V	1895	1581	980	616	381	275	216	184	131	109	58.3
4.95V	1839	1543	960	606	379	274	215	183	130	109	58.2
5.10V	1763	1486	931	591	375	272	213	182	129	109	58.0
5.25V	1687	1436	908	573	370	270	212	181	128	108	57.6
5.40V	1592	1360	875	554	360	264	205	175	124	107	57.2

Note: The above characteristics data can be obtained within three charge or discharge cycles.

NPG6-180Ah 6V180Ah

Discharge characteristics(25°C)

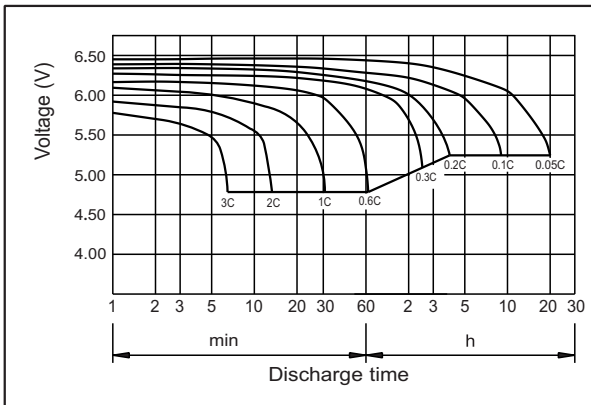

Charging characteristics(25°C)

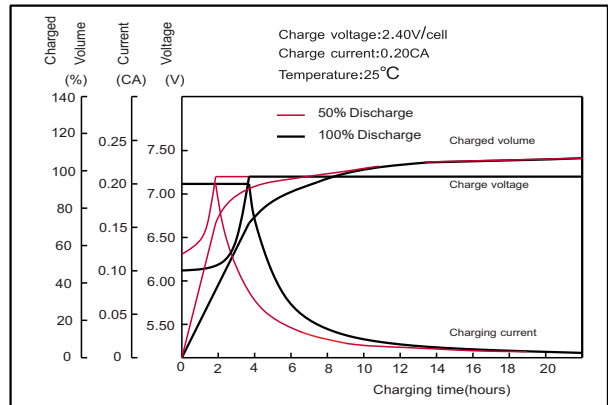

Effect of temperature on capacity

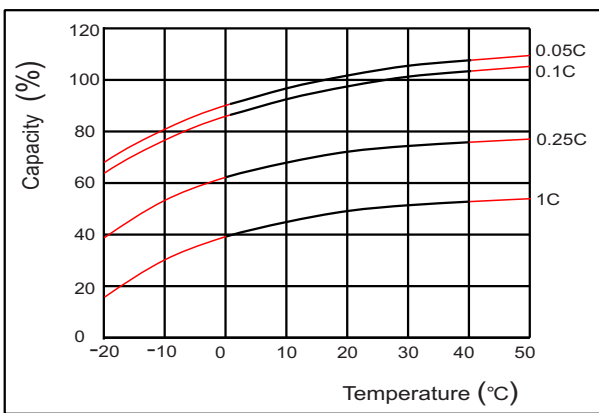

Self-discharge characteristics

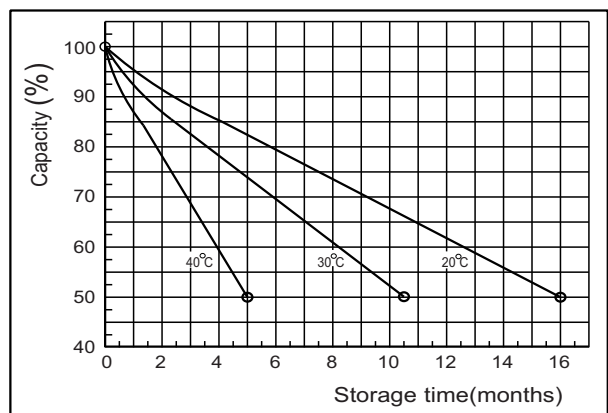

Floating life on temperature

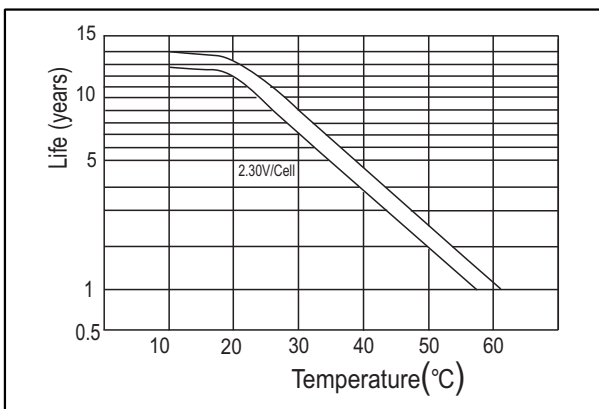

Cycle life on D.O.D (25°C)

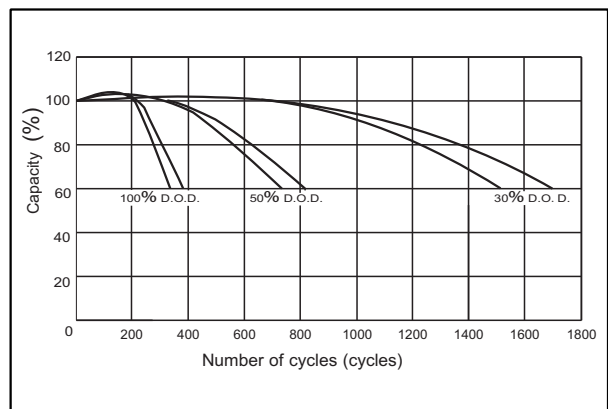

The relationship for OCV and Capacity (25°C)

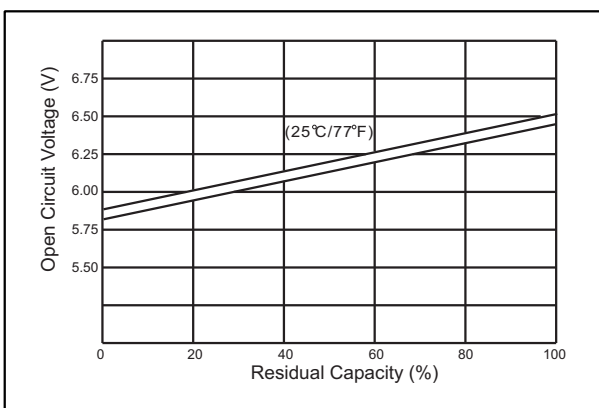

The relationship for Charging voltage and Temperature

