

NPG2-800Ah 2V800Ah



Specifications

Nominal Voltage	2V	
Rated capacity (20 hour rate)	800Ah	
Dimensions	Length	410±2mm(16.14inch)
	Width	175±2mm(6.89inch)
	Height	330±2mm(12.99inch)
	Total Height	365±2mm(14.37inch)
Approx. Weight	53kg(116.6lbs)±3%	

Outer dimensions (mm)

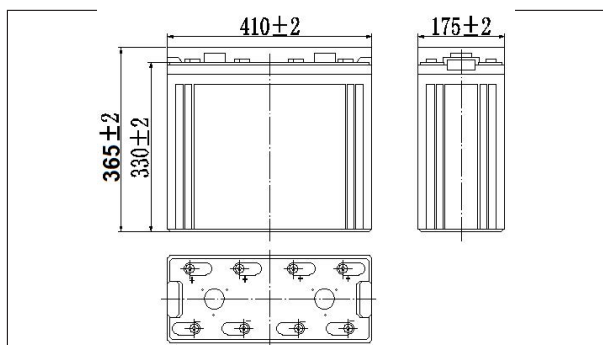

Terminal Type (mm)

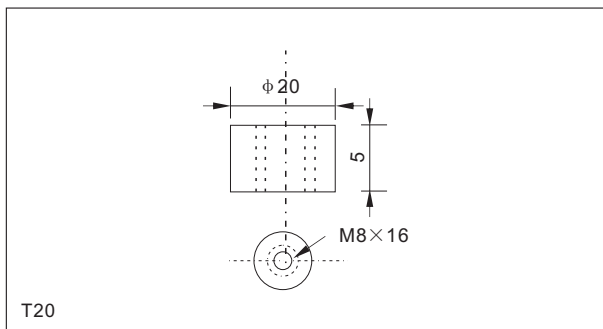

Characteristics

Capacity (25°C)	20HR(1.8V)	800Ah
	3HR(1.80V)	600Ah
	1HR(1.75V)	440Ah
Terminal type		T20
Internal resistance (Fully charged, 25°C)		Approx.0.4m Ω
Capacity affected by temperature (20HR)	40°C	102%
	25°C	100%
	0°C	85%
	-15°C	65%
Self-discharge (25°C)	3 months	Remaining Capacity:91%
	6 months	Remaining Capacity:82%
	12 months	Remaining Capacity:65%
Nominal operating temperature		25°C ±3°C(77°F ±5°F)
Operating temperature range	Discharge	-15°C~50°C(5°F~122°F)
	Charge	-10°C~50°C(14°F~122°F)
	Storage	-20°C~50°C(-4°F~122°F)
Float charging voltage(25°C)		2.25 to 2.30V Temperature compensation: -3mV/°C
Cyclic charging voltage(25°C)		2.40 to 2.45V Temperature compensation: -5mV/°C
Maximum charging current		160A
Maximum discharge current		4400A(5 sec.)
Designed floating life(20°C)		18 years

Construction

Component	Positive plate	Negative plate	Container	Cover	Separator	Electrolyte	Safety valve	Terminal
Raw material	Lead dioxide	Lead	ABS	ABS	AGM	Gel	Rubber	Copper

Constant Current Discharge Characteristics Unit:A(25°C,77°F)

F.V/Time	15min	30min	60min	2h	3h	4h	5h	6h	8h	10h	20h
1.60V	1000	696	480	288	209	165	137	121	96.3	81.4	42.8
1.65V	976	682	470	287	208	164	136	120	95.7	81.3	42.7
1.70V	940	661	456	284	206	163	135	119	95.1	81.0	42.5
1.75V	908	645	446	280	205	162	134	118	94.4	80.6	42.3
1.80V	860	622	432	273	201	157	130	115	91.6	80.0	42.0

Constant Power Discharge Characteristics Unit:W(25°C,77°F)

F.V/Time	15min	30min	60min	2h	3h	4h	5h	6h	8h	10h	20h
1.60V	1830	1302	912	556	409	323	270	238	192	162	85.5
1.65V	1786	1275	894	553	407	321	268	237	190	162	85.3
1.70V	1720	1236	866	548	404	319	267	235	189	161	85.1
1.75V	1662	1207	848	540	401	317	265	233	188	160	84.6
1.80V	1574	1162	821	526	393	307	257	226	182	159	84.0

Note: The above characteristics data can be obtained within three charge or discharge cycles.

NPG2-800Ah 2V800Ah

● **Discharge characteristics(25°C)**

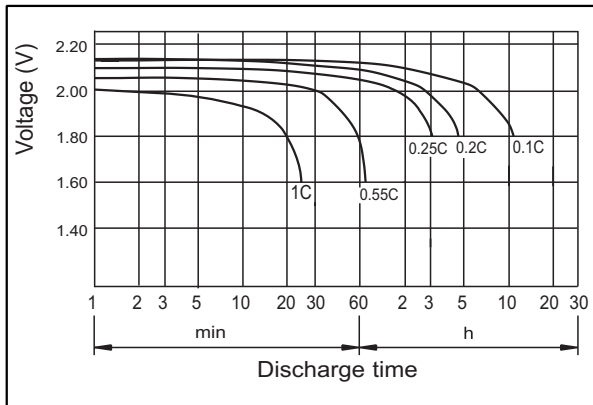

● **Charging characteristics**

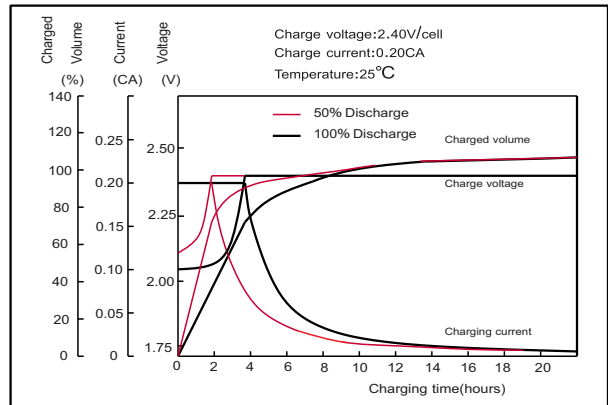

● **Effect of Temperature on Capacity**

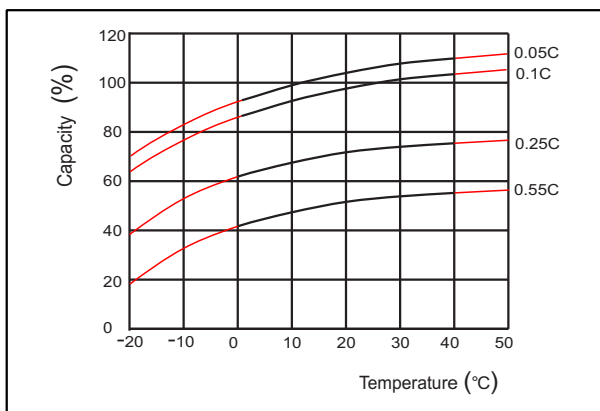

● **Self-discharge characteristics**

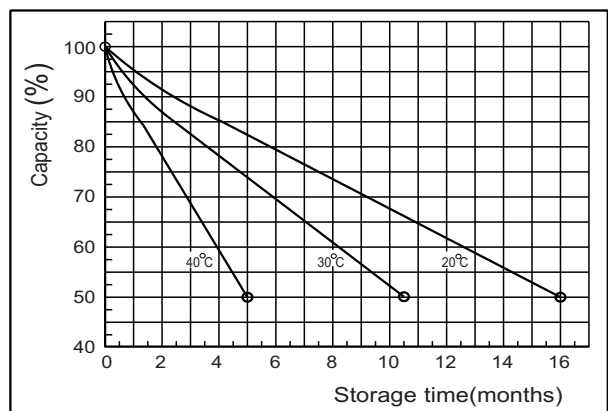

● **Temperature effects on float life**

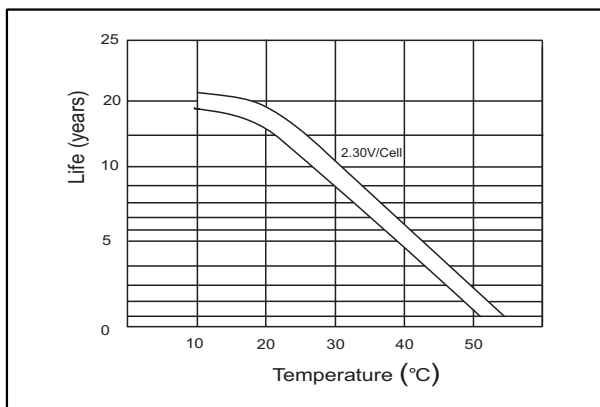

● **Cycle service life in relation to depth of discharge**

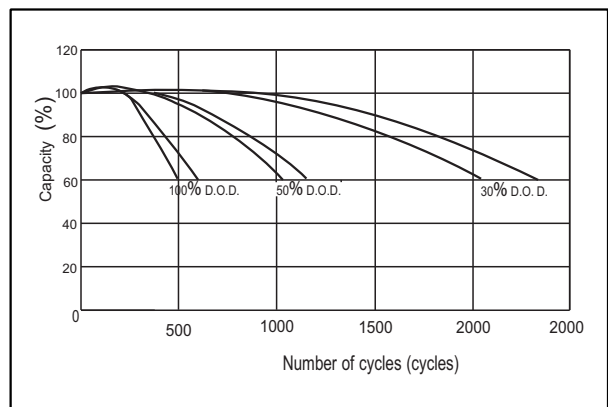

● **The relationship for OCV and Capacity (25°C)**

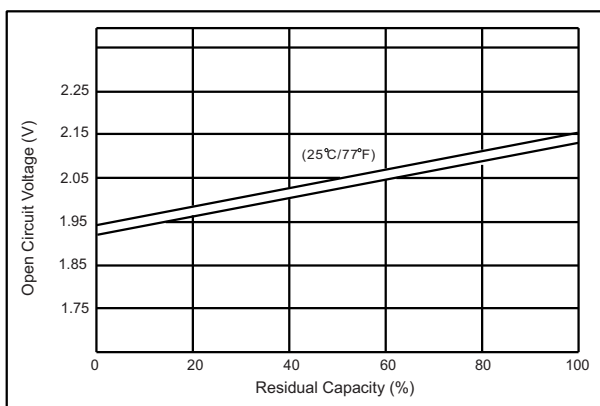

● **The relationship for Charging voltage and Temperature**

