

NPG12-250Ah 12V250Ah

Specifications

Nominal Voltage	12V	
Rated capacity (20 hour rate)	250Ah	
Dimensions	Length	520±2mm(20.47inch)
	Width	268±2mm(10.55inch)
	Height	220±2mm(8.66inch)
	Total Height	243±2mm(9.57inch)
Approx. Weight	74.5kg(163.39lbs)±3%	



Outer dimensions (mm)

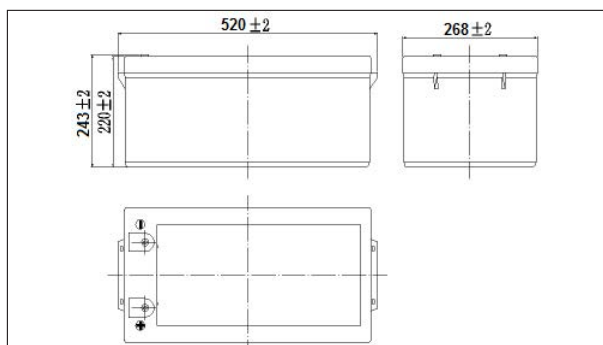

Terminal Type (mm)

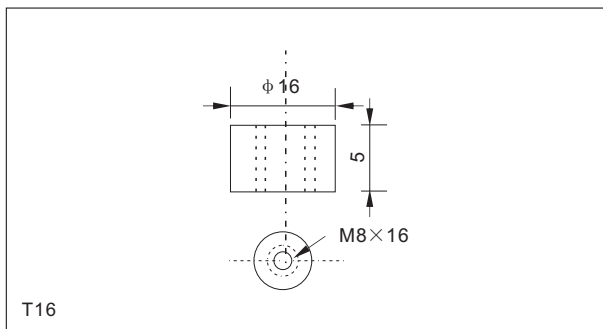

Characteristics

Capacity (25°C)	20HR(10.8V)	250Ah
	3HR(10.8V)	187.5Ah
	1HR(10.5V)	140Ah
Terminal type		T16
Internal resistance (Fully charged,25°C)		Approx.2.8m Ω
Capacity affected by temperature (20HR)	40°C	102%
	25°C	100%
	0°C	85%
	-15°C	65%
Self-discharge (25°C)	3 months	Remaining Capacity:91%
	6 months	Remaining Capacity:82%
	12 months	Remaining Capacity:65%
Nominal operating temperature		25°C ±3°C(77°F ±5°F)
Operating temperature range	Discharge	-15°C~50°C(5°F~122°F)
	Charge	-10°C~50°C(14°F~122°F)
	Storage	-20°C~50°C(-4°F~122°F)
Float charging voltage(25°C)		13.50 to 13.80V Temperature compensation: -18mV/°C
Cyclic charging voltage(25°C)		14.40 to 14.70V Temperature compensation: -30mV/°C
Maximum charging current		50A
Maximum discharge current		1500A(5 sec.)
Designed floating life(20°C)		12years

Construction

Component	Positive plate	Negative plate	Container	Cover	Separator	Electrolyte	Safety valve	Terminal
Raw material	Lead dioxide	Lead	ABS	ABS	AGM	Gel	Rubber	Copper

Constant Current Discharge Characteristics Unit:A(25°C,77°F)

F.V/Time	15min	30min	60min	2h	3h	4h	5h	6h	8h	10h	20h
9.60V	400	243	150	91.4	65.0	51.0	43.4	38.3	30.6	25.5	13.5
9.90V	390	238	148	90.8	64.6	50.7	43.1	38.0	30.4	25.4	13.5
10.2V	376	230	144	90.0	64.2	50.4	42.8	37.8	30.2	25.3	13.4
10.5V	363	225	140	88.7	63.8	50.0	42.5	37.5	30.0	25.2	13.3
10.8V	344	217	135	86.4	62.5	48.5	41.2	36.4	29.1	25.0	13.3

Constant Power Discharge Characteristics Unit:W(25°C,77°F)

F.V/Time	15min	30min	60min	2h	3h	4h	5h	6h	8h	10h	20h
9.60V	4392	2721	1710	1058	765	600	512	452	364	304	162
9.90V	4287	2666	1684	1052	760	596	509	449	361	303	162
10.2V	4128	2585	1642	1042	755	592	506	446	359	302	161
10.5V	3988	2522	1590	1027	750	588	502	443	356	301	160
10.8V	3777	2430	1539	1001	735	570	487	430	346	299	159

Note: The above characteristics data can be obtained within three charge or discharge cycles.

NPG12-250Ah 12V250Ah

● **Discharge characteristics(25°C)**

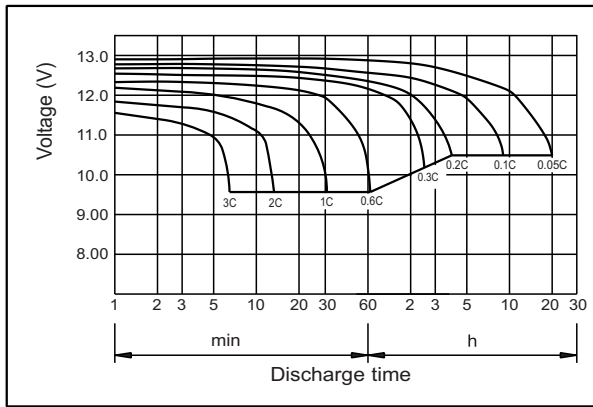

● **Charging characteristics (25°C)**

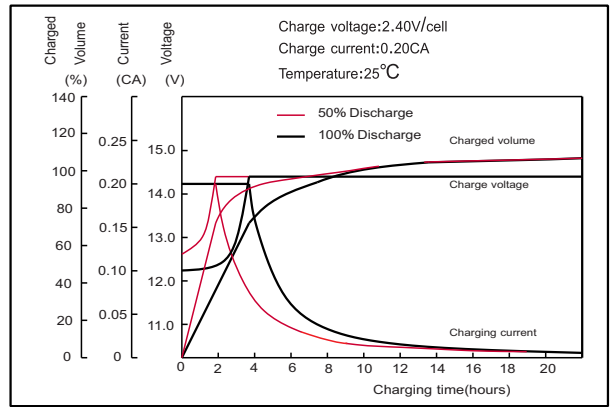

● **Temperature effects on Capacity**

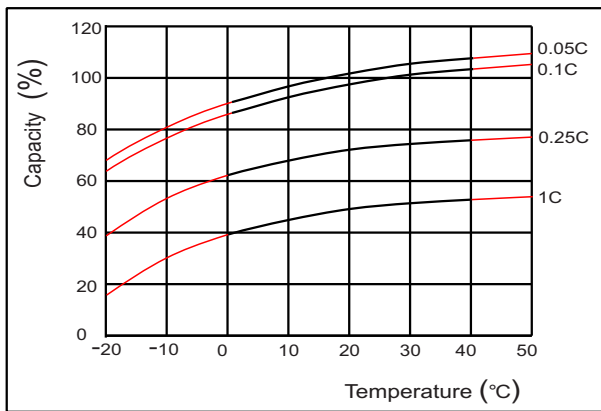

● **Self-discharge characteristics**

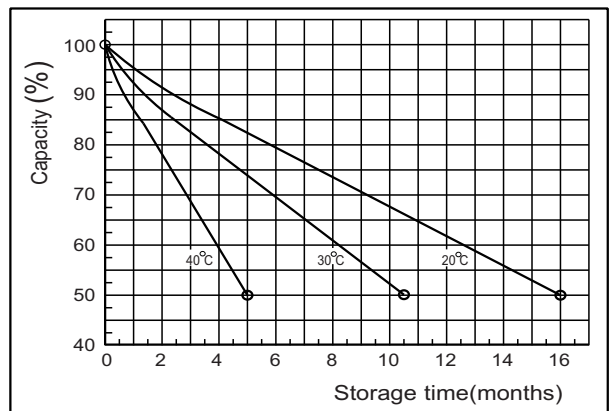

● **Floating life on Temperature**

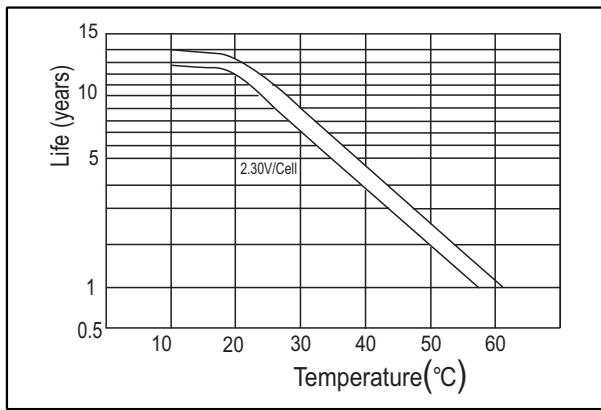

● **Cycle life on D.O.D (25°C)**

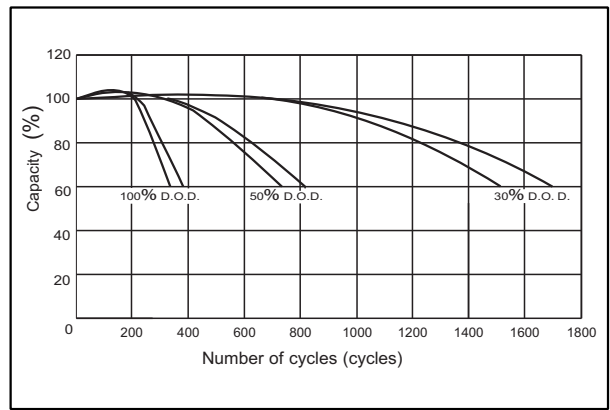

● **The relationship for OCV and Capacity (25°C)**

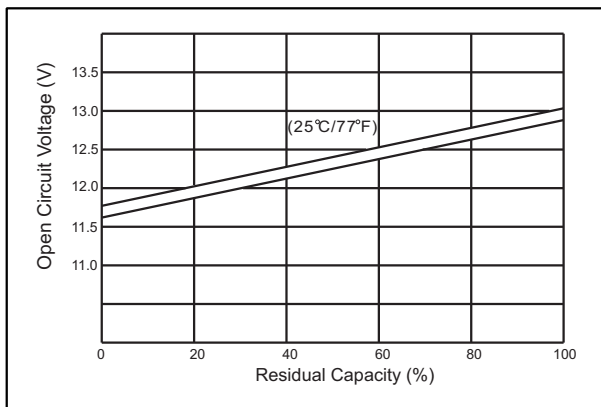

● **The relationship for Charging voltage and Temperature**

