

NPD12-65Ah 12V65Ah

Specifications

Nominal Voltage	12V	
Rated capacity (20 hour rate)	65Ah	
Dimensions	Length	350±2mm(13.78inch)
	Width	166±2mm(6.54inch)
	Height	179±2mm(7.05inch)
	Total Height	179±2mm(7.05inch)
Approx. Weight	21kg(46.2lbs)±3%	



Outer dimensions (mm)

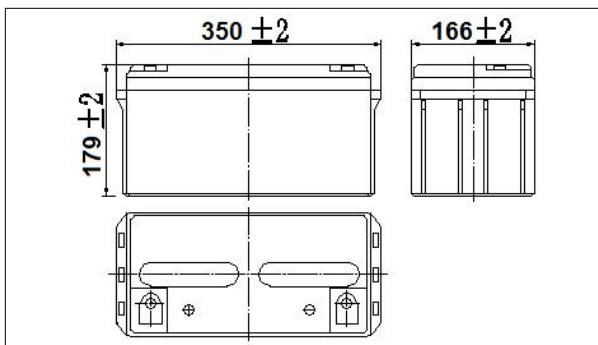

Terminal Type (mm)

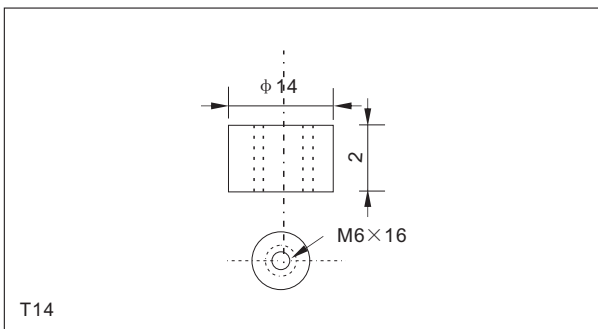

Characteristics

Capacity (25°C)	20HR(10.8V)	65Ah
	3HR(10.8V)	51Ah
	1HR(10.5V)	37Ah
Terminal type		T14
Internal resistance (Fully charged, 25°C)		Approx. 6.5m Ω
Capacity affected by temperature (20HR)	40°C	102%
	25°C	100%
	0°C	85%
	-15°C	65%
Self-discharge (25°C)	3 months	Remaining Capacity:91%
	6 months	Remaining Capacity:82%
	12 months	Remaining Capacity:65%
Nominal operating temperature		25°C ±3°C(77°F ±5°F)
Operating temperature range	Discharge	-15°C~50°C(5°F~122°F)
	Charge	-10°C~50°C(14°F~122°F)
	Storage	-20°C~50°C(-4°F~122°F)
Float charging voltage(25°C)		13.50 to 13.80V Temperature compensation: -18mV/°C
Cyclic charging voltage(25°C)		14.50 to 15.00V Temperature compensation: -30mV/°C
Maximum charging current		19.5A
Maximum discharge current		650A(5 sec.)
Designed floating life(20°C)		10years

Construction

Component	Positive plate	Negative plate	Container	Cover	Separator	Electrolyte	Safety valve	Terminal
Raw material	Lead dioxide	Lead	ABS	ABS	AGM	Sulfuric acid	Rubber	Copper

Constant Current Discharge Characteristics Unit:A(25°C,77°F)

F.V/Time	10min	15min	30min	60min	2h	3h	4h	5h	8h	10h	20h
9.60V	148	114	68.3	42.0	24.8	17.9	14.3	12.2	8.39	6.92	3.67
9.90V	144	111	67.0	41.4	24.7	17.8	14.2	12.1	8.34	6.91	3.66
10.2V	138	107	64.9	40.3	24.5	17.7	14.1	12.1	8.29	6.89	3.65
10.5V	132	104	63.4	39.1	24.1	17.5	14.0	12.0	8.23	6.85	3.63
10.8V	125	98.2	61.0	37.8	23.5	17.0	13.6	11.6	7.98	6.80	3.60

Constant Power Discharge Characteristics Unit:W(25°C,77°F)

F.V/Time	10min	15min	30min	60min	2h	3h	4h	5h	8h	10h	20h
9.60V	1601	1254	767	479	288	210	168	144	99.7	82.7	44.0
9.90V	1553	1224	751	472	286	209	167	143	99.1	82.5	43.9
10.2V	1489	1179	728	460	283	208	166	142	98.4	82.2	43.8
10.5V	1425	1139	711	446	279	206	165	141	97.7	81.8	43.6
10.8V	1345	1079	685	431	272	200	160	137	94.8	81.2	43.2

Note: The above characteristics data can be obtained within three charge or discharge cycles.

NPD12-65Ah 12V65Ah

● **Discharge characteristics(25°C)**

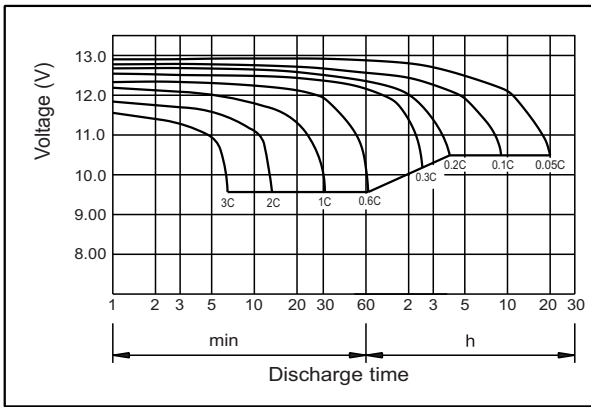

● **Charging characteristics (25°C)**

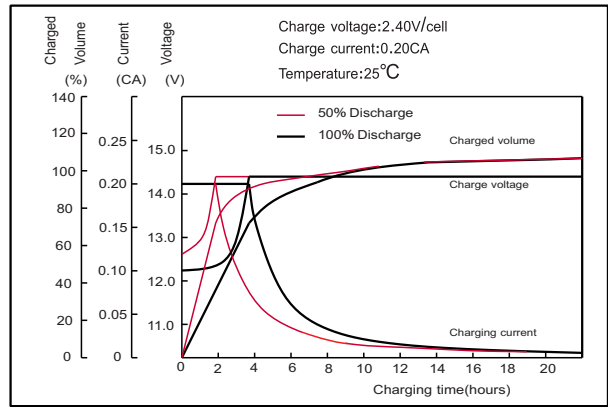

● **Temperature effects on Capacity**

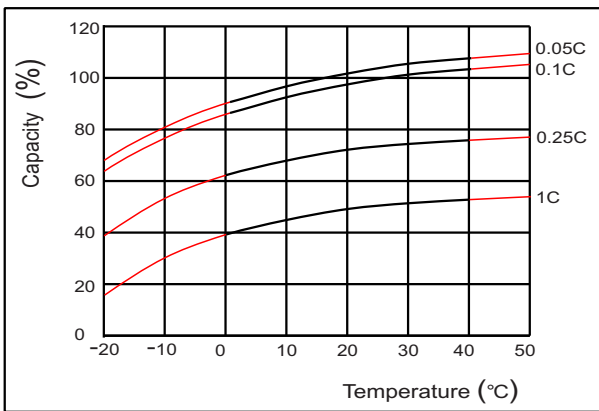

● **Self-discharge characteristics**

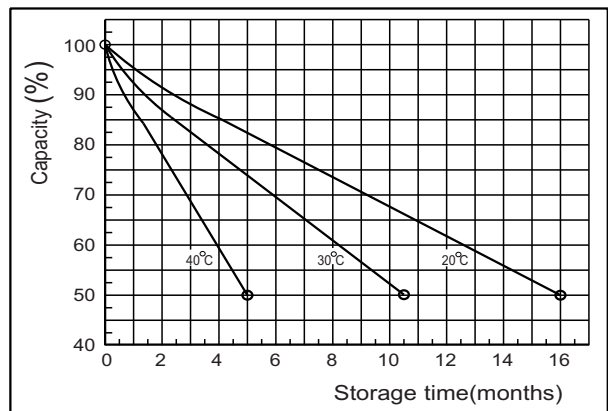

● **Floating life on Temperature**

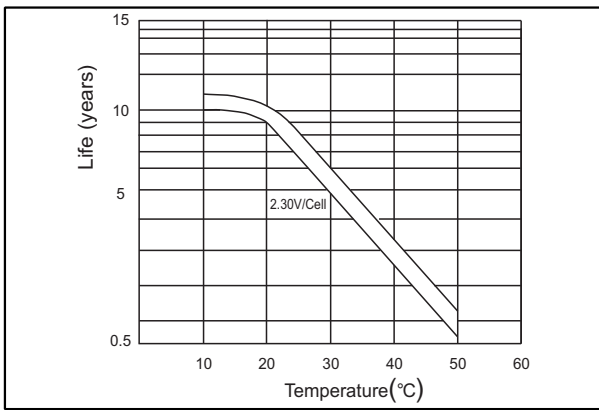

● **Cycle life on D.O.D (25°C)**

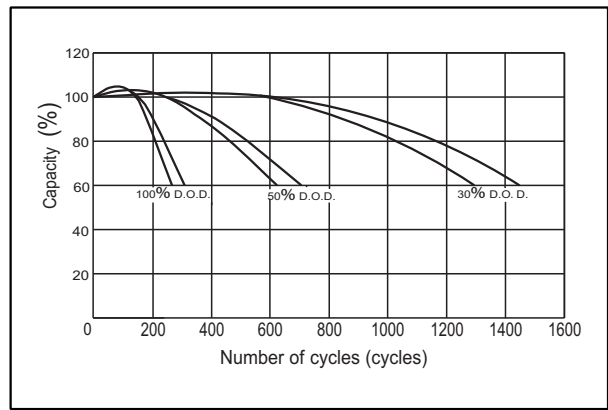

● **The relationship for OCV and Capacity (25°C)**

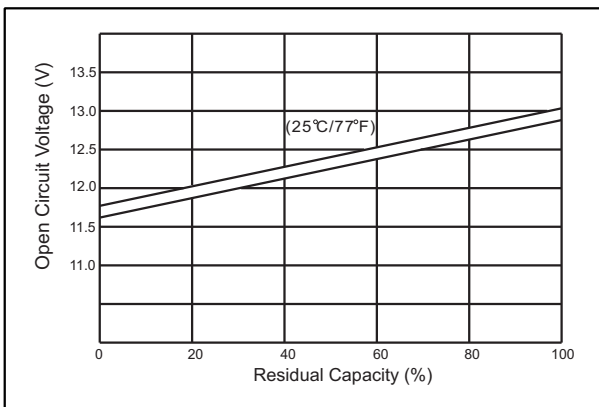

● **The relationship for Charging voltage and Temperature**

