

HR1251W-FR (12V51 Watts/cell)

● Specifications

Nominal Voltage		12V
Number of cell		6 cells
Rated capacity(15min.rat)		51 Watts/cell
Dimensions	Length	151±1.5mm(5.94inch)
	Width	98±1mm(3.86inch)
	Height	94±1mm(3.7inch)
	Total Height	100±1mm(3.94inch)
Approx. Weight		4kg(9.04lbs)±4%



● Outer dimensions (mm)

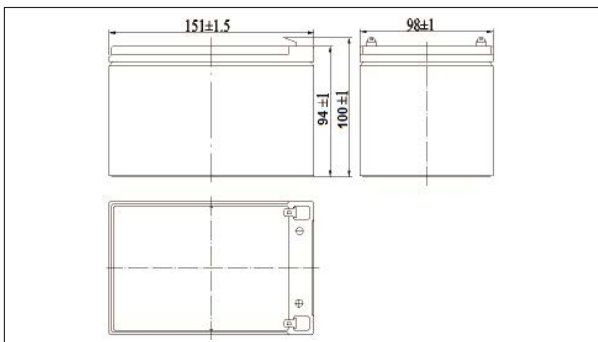

● Terminal Type (mm)

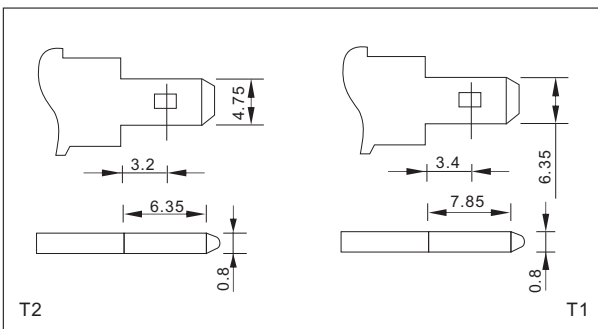

● Characteristics

Capacity(20HR,25°C)		14Ah
Capacity(15min.rate,25°C)		51 Watts/cell
Terminal type		T2/T1
Internal resistance (Fully charged,25°C)		Approx. 11m Ω
Capacity affected by temperature (20HR)	40°C	102%
	25°C	100%
	0°C	85%
	-15°C	65%
Self-discharge (25°C)	3 months	Remaining Capacity:91%
	6 months	Remaining Capacity:82%
	12 months	Remaining Capacity:65%
Nominal operating temperature		25°C ±3°C(77°F ±5°F)
Operating temperature range	Discharge	-15°C~50°C(5°F~122°F)
	Charge	-10°C~50°C(14°F~122°F)
	Storage	-20°C~50°C(-4°F~122°F)
Float charging voltage(25°C)		13.50 to 13.80V Temperature compensation: -18mV/°C
Cyclic charging voltage(25°C)		14.50 to 15.00V Temperature compensation: -30mV/°C
Maximum charging current		3.6A
Maximum discharge current		180A(5 sec.)
Designed floating life(20°C)		5years

● Construction

Component	Positive plate	Negative plate	Container	Cover	Separator	Electrolyte	Safety valve	Terminal
Raw material	Leaddioxide	Lead	ABS	ABS	AGM	Sulfuric acid	Rubber	Copper

● Constant Current Discharge Characteristics Unit:A(25°C,77°F)

F.V/Time	5min	10min	15min	20min	30min	45min	60min	2h	3h	4h	5h
1.60V/cell	55.3	34.0	26.7	21.2	14.3	10.6	8.68	4.78	3.39	2.73	2.35
1.67V/cell	52.8	32.5	25.8	20.3	13.9	10.3	8.46	4.73	3.36	2.71	2.33
1.70V/cell	51.4	31.7	25.1	19.9	13.6	10.1	8.33	4.71	3.35	2.70	2.32
1.75V/cell	49.2	30.3	24.3	19.2	13.3	9.84	8.17	4.64	3.33	2.68	2.30
1.80V/cell	46.4	28.6	23.0	18.2	12.8	9.48	7.92	4.52	3.23	2.60	2.33

● Constant Power Discharge Characteristics Unit:W(25°C,77°F)

F.V/Time	5min	10min	15min	20min	30min	45min	60min	2h	3h	4h	5h
1.60V/cell	106	66.0	52.9	41.9	28.4	21.0	17.2	9.51	6.82	5.49	4.72
1.67V/cell	101	63.1	51.1	40.2	27.5	20.3	16.8	9.42	6.76	5.44	4.68
1.70V/cell	98.7	61.4	49.8	39.4	27.0	20.0	16.5	9.36	6.74	5.42	4.66
1.75V/cell	94.4	58.8	48.1	38.0	26.3	19.5	16.2	9.22	6.69	5.38	4.63
1.80V/cell	89.1	55.5	45.5	36.0	25.3	18.8	15.7	8.99	6.49	5.22	4.49

Note: The above characteristics data can be obtained within three charge or discharge cycles.

HR1251W-FR (12V51 Watts/cell)

Discharge characteristics(25°C)

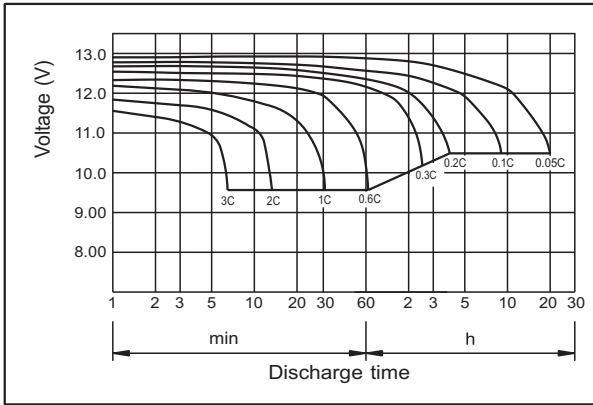

Charging characteristics (25°C)

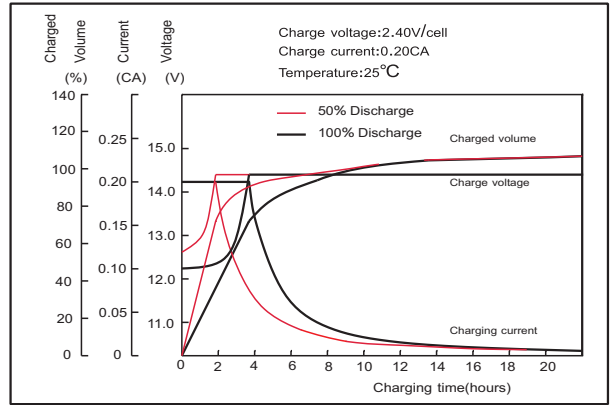

Effect of Temperature on Capacity

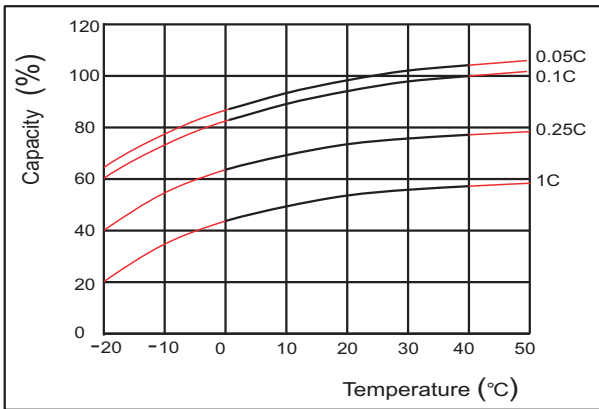

Self-discharge characteristics

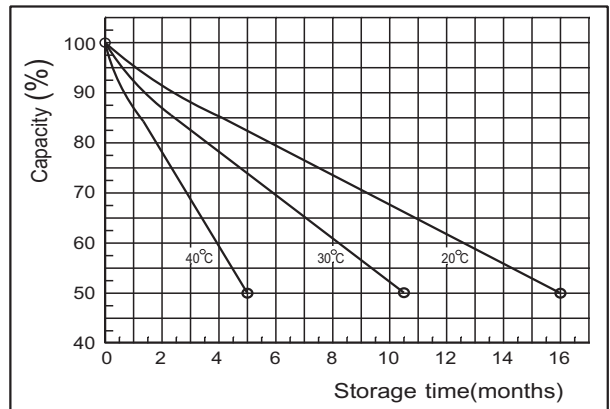

Floating Life on Temperature

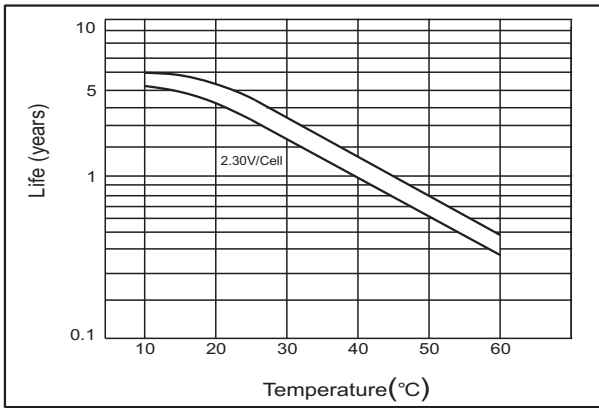

Cycle service Life on D.O.D (25°C)

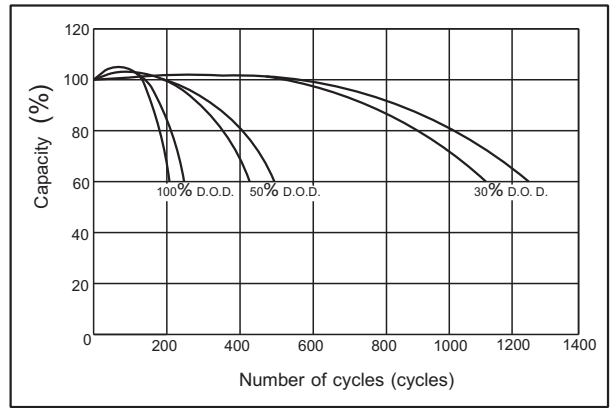

The relationship for OCV and Capacity (25°C)

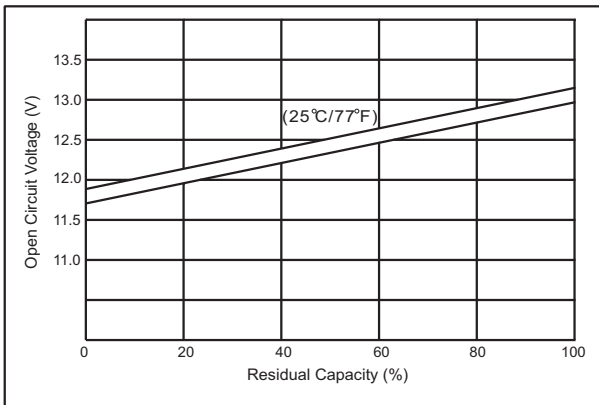

The relationship for Charging voltage and Temperature

