

## FT12-75Ah 12V75Ah

### Specifications

Nominal Voltage		12V
Rated capacity (10 hour rate)		75Ah
Dimensions	Length	562±2mm(22.13inch)
	Width	114±2mm(4.49inch)
	Height	188±2mm(7.4inch)
	Total Height	188±2mm(7.4inch)
Approx. Weight		25kg(55lbs)±3%



### Outer dimensions (mm)

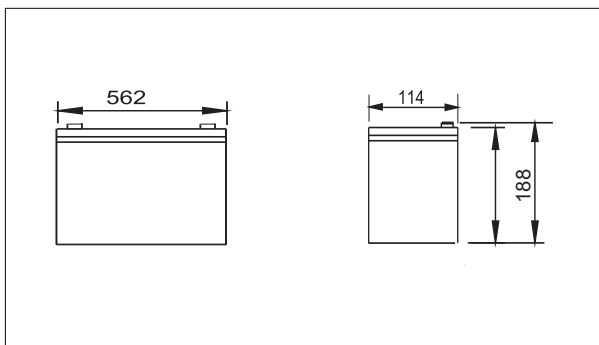

### Terminal Type (mm)

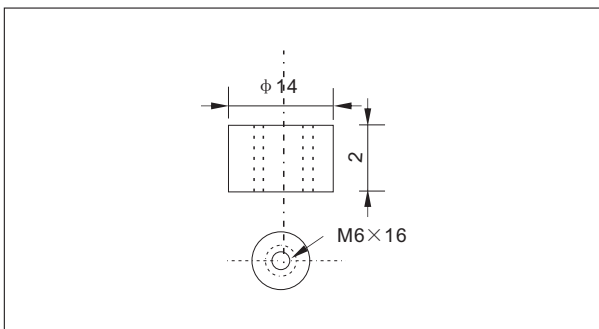

### Characteristics

Capacity (25°C)	10HR(10.8V)	75Ah
	3HR(10.8V)	57Ah
	1HR(10.5V)	41.5Ah
Terminal type		T14
Internal resistance (Fully charged,25°C)		Approx.6m Ω
Capacity affected by temperature (10HR)	40°C	102%
	25°C	100%
	0°C	85%
	-15°C	65%
Self-discharge (25°C)	3month	Remaining Capacity:91%
	6month	Remaining Capacity:82%
	12month	Remaining Capacity:65%
Nominal operating temperature		25°C±3°C(77°F±5°F)
Operating temperature range	Discharge	-15°C~50°C(5°F~122°F)
	Charge	-10°C~50°C(14°F~122°F)
	Storage	-20°C~50°C(-4°F~122°F)
Float charging voltage(25°C)		13.50 to 13.80V Temperature compensation: -18mV/°C
Cyclic charging voltage(25°C)		14.50 to 15.00V Temperature compensation: -30mV/°C
Maximum charging current		22.5A
Terminal material		Copper
Maximum discharge current		600A(5 sec.)
Designed floating life(20°C)		12years

### Construction

Component	Positive plate	Negative plate	Container	Cover	Separator	Electrolyte	Safety valve	Terminal
Raw material	lead dioxide	Lead	ABS	ABS	AGM	Sulfuric acid	Rubber	Copper

### Constant Current Discharge Characteristics Unit:A(25°C,77°F)

F.V/Time	10min	15min	30min	60min	2h	3h	4h	5h	8h	10h	20h
9.60V	160	123	73.9	45.4	27.4	19.7	15.8	13.5	9.26	7.64	4.05
9.90V	155	121	72.4	44.7	27.2	19.6	15.7	13.4	9.20	7.62	4.04
10.2V	149	116	70.2	43.6	27.0	19.5	15.6	13.3	9.14	7.60	4.03
10.5V	143	112	68.5	42.2	26.6	19.5	15.5	13.2	9.08	7.55	4.00
10.8V	135	106	66.0	40.9	25.9	18.8	15.0	12.8	8.80	7.50	3.98

### Constant Power Discharge Characteristics Unit:W(25°C,77°F)

F.V/Time	10min	15min	30min	60min	2h	3h	4h	5h	8h	10h	20h
9.60V	1730	1356	829	518	317	232	185	159	110	91.2	48.6
9.90V	1679	1323	812	510	315	231	184	158	109	91.0	48.5
10.2V	1609	1274	787	497	313	229	183	157	109	90.7	48.3
10.5V	1540	1231	768	482	308	228	182	156	108	90.2	48.0
10.8V	1454	1166	740	466	300	221	176	151	105	89.6	47.7

Note: The above characteristics data can be obtained within three charge or discharge cycles.

# FT12-75Ah 12V75Ah

● **Discharge characteristics(25°C)**

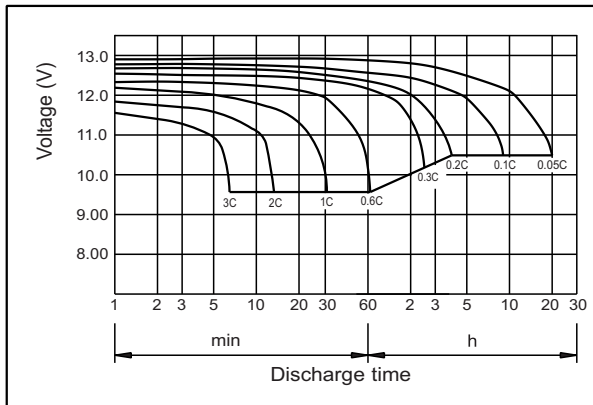

● **Charging characteristics**

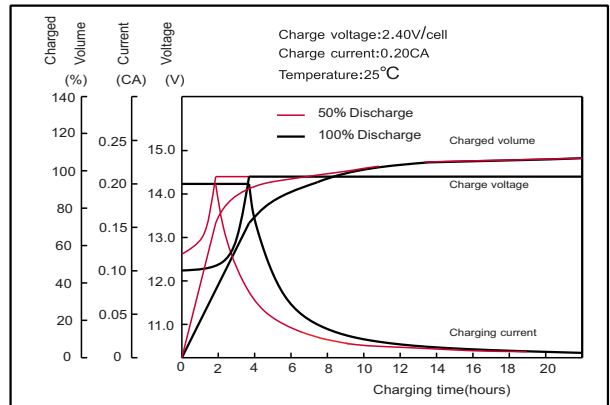

● **Temperature effects on Capacity**

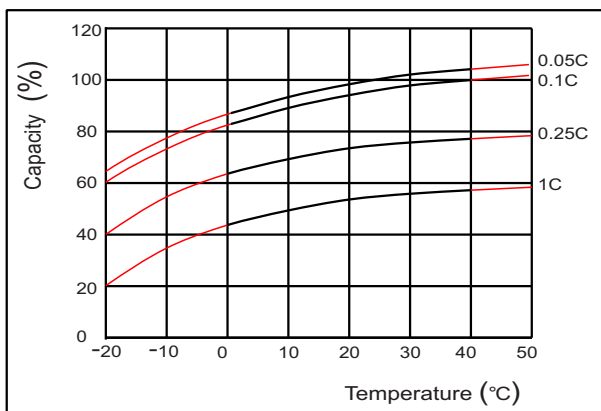

● **Self-discharge characteristics**

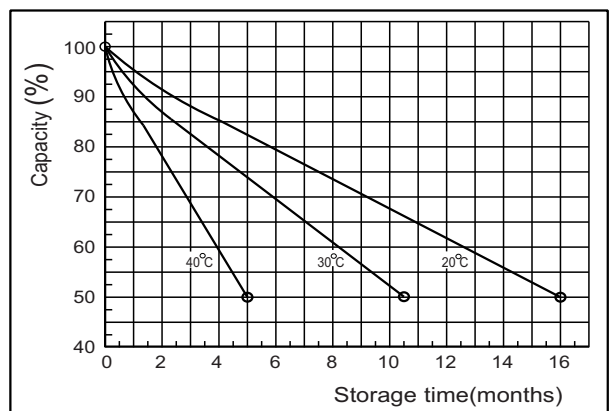

● **Temperature effects on float life**

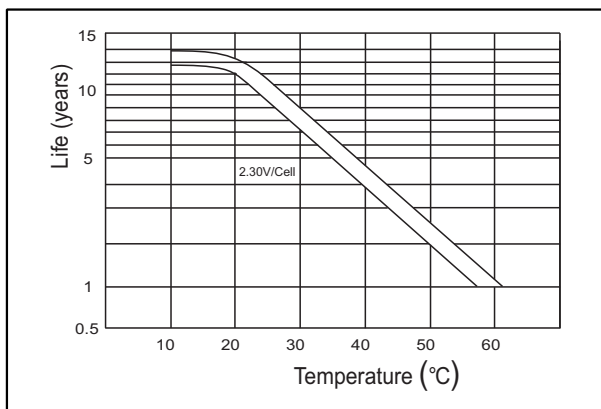

● **Cycle service life in relation to depth of discharge**

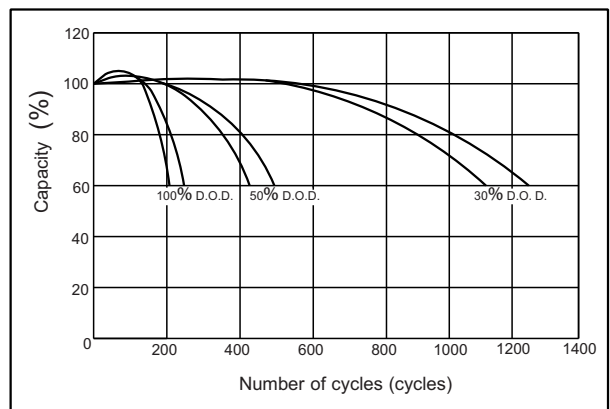

● **The relationship for OCV and Capacity (25°C)**

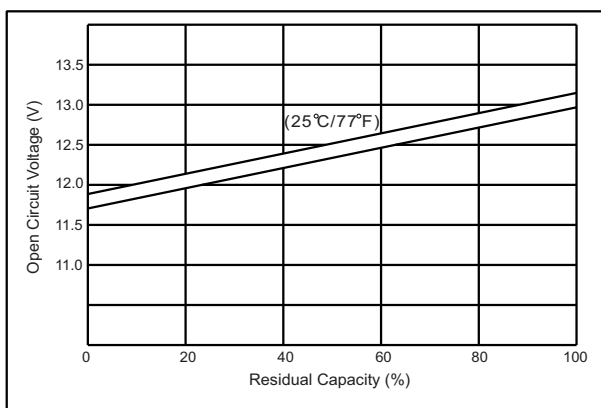

● **The relationship for Charging voltage and Temperature**

